













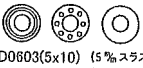







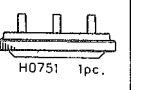



























1/8th Scale 4WD Gas Powered Racing Car MRX-4X Parts List



D0601  D0601(12x21) 2pcs.	H0601  H0601(12x18) 2pcs.	D0602  D0602(6x13) 2pcs.
C0603  C0603(5x10) 2pcs.	D0603  D0603(5x10) (5% スラストベアリング) (5% THRUST B.B.)	
H0603  H0603(5x10) 2pcs. FLANGE BEARING	C0605  C0605(6x10) 2pcs.	H0608  H0608(10x15) 2pcs. FLANGE BEARING
H0704  H0704 1pc.	H0707 OPT  H0707 BLACK 1pc.	H0721 OPT  H0721 1pc.
C0723  SJG 4x10 4pcs.  D0701B 4pcs.	H0751 OPT  H0751 1pc.	H0752 OPT  H0752 4pcs.
H0753  H0753 1pc.	H0755  H0755 1pc.	H0756  H0756 1pc. φ5.2xφ10x0.1 10pcs.
H0757 OPT  16T H0757 1pc.	H0758  17T H0758 1pc.	H0759 OPT  18T H0759 1pc.
H0760 OPT  19T H0760 1pc.	H0761  20T H0761 1pc.	H0762 OPT  21T H0762 1pc.
H0764 OPT  H0764 1pc.	H0765 OPT  H0765 GRAY 1pc.	H0766 OPT  H0766 4pcs.















H0767  H0767 1pc.	H0769 OPT  H0769 RED 1pc.	H0770  H0770L 1pc.  H0770R 1pc.
---	---	--

H0771 OPT					
 H0771 1pc.	 H0773 1pc.	 H0721 1pc.	 H0710 1pc.	 H0704 1pc.	 H0756 1pc.
 H0753 1pc.	 H0766 4pcs.	 φ5.2xφ10x0.1 10pcs.	 H0767 1pc.	 D0803 2pcs.	 SG3x16 1pc.







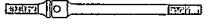

H0772 OPT  H0772 1pc.	H0773 OPT  H0773 YELLOW 1pc.	H0774 OPT  H0774 1pc.
---	--	--

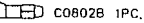
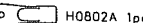
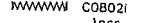
H0775  H0775 3pcs.	H0776  H0776 1pc.	H0777  H0777 1pc.
--	---	--

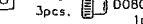
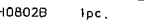
H0778  H0778 1pc.	H0779  H0779 1pc.
---	---





H0780					
 H0775 3pcs.	 H0776 1pc.	 H0777 1pc.	 H0778 1pc.	 H0779 1pc.	 H0704 1pc.
 H0753 1pc.	 H0756 1pc.	 φ5.2xφ10x0.1 10pcs.	 H0767 1pc.	 C0603 2pcs.	 D0803 1pc.
 H0755 1pc.	 SG3x16 1pc.				



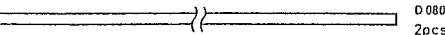



H0801A  H0801A 2pcs.
--

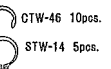
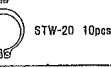

H0802					
 C0802B 1pc.	 H0802A 1pc.	 C0802H 1pcs.	 SK 3x3 3pcs.	 Si 3x10 2pcs.	 C0802C 1pc.
 C0802G 2pcs.	 C0802H 3pcs.	 D0802A 1pc.			
 H0802B 1pc.	 C0802J 1pcs.				



- H0767 CLUTCH SPRING SUPER HARD
- H0769 CLUTCH SHOE (RED)
- H0770 ENGINE MOUNT
- H0771 CLUTCH SET
- H0772 ONE PIECE ENGINE MOUNT
- H0773 CLUTCH SHOE (YELLOW)
- H0774 CLUTCH SPRING ULTRA HARD
- H0775 CENTRIFUGAL SHOE
- H0776 AL. PRESSURE PLATE
- H0777 CLUTCH BELL
- H0778 FLYWHEEL
- H0779 CLUTCH SHOE (YELLOW)
- H0780 CLUTCH SET FOR MRX-4X
- H0801A STEERING ROD
- H0802 ENGINE CONTROL LINKAGE

D0806  D0806 2pcs.
--



D0807  D0807 8pcs.	H0851  OE-2.5 10pcs.  OE-3 5pcs.  OE-7 10pcs.
--	---

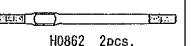

H0852  CTW-46 10pcs.  STW-14 5pcs.  STW-20 10pcs.	H0853  φ3x11.6 Pin 10pcs.	H0854  φ2.5x11.6 Pin 2pcs.  φ3x20 Pin 2pcs.  φ3x22 Pin 2pcs.  φ3x23.8 Pin 3pcs.
---	---	--

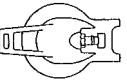
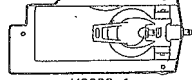
H0855  C0111C 10pcs.	H0856  C0111E 4pcs.	H0857  H0857 2pcs.
--	---	--

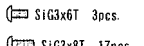
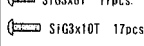
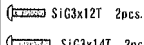
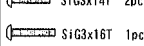
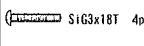

H0858  H0858 10pcs.	H0862 OPT  H0862 2pcs.	H0863 OPT  H0863 2pcs.
---	--	--

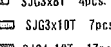
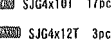

H0864  H0864 1pc.	H0866  H0866 1pc.
---	---

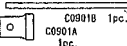
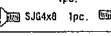
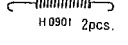
H0867  H0867 4pcs. (Silver)	H0868 OPT  SiG3x6T 3pcs. SJG3x6T 6pcs.  SiG3x8T 17pcs. SJG3x8T 8pcs.  SiG3x10T 17pcs. SJG3x10T 21pcs.  SiG3x12T 2pcs. SJG3x12T 6pcs.  SiG3x14T 2pcs. SJG4x8T 1pc.  SiG3x16T 1pc. SJG4x12T 2pcs.  SiG3x18T 4pcs.
--	--

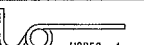
H0869 OPT	
 SJG3x8T 4pcs.	 SJG3x10T 7pcs.
 SJG4x10T 17pcs.	 SJG4x12T 3pcs.

C0901  C0901 1pc.  SJG4x8 1pc. SK4x5 1pc.	H0901 OPT  H0901 2pcs.
--	--

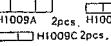
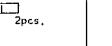
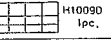

H0952  H0952 1pc.	H1006 OPT  H1006A 2pcs.  H1006B 2pcs.
---	--

H1009 OPT	
 H1009A 2pcs.	 H1009B 2pcs.
 H1009C 2pcs.	 H1009D 1pc.

- D0806 ANTENNA PIPE
- D0807 BODY PIN
- H0851 E-RING SET
- H0852 SNAP RING SET
- H0853 ROLLER PIN SET φ3x11.6
- H0854 ROLLER PIN SET
- H0855 BALL LINK φ6mm
- H0856 STABILIZER LINK BALL
- H0857 TURN BUCKLE ROD (22mm)
- H0858 BALL LINK φ6mm (S)
- H0862 TITANIUM STEERING ROD
- H0863 TITANIUM TURN BUCKLE ROD (22mm)
- H0864 FUEL TANK CAP
- H0866 FUEL TANK
- H0867 PIVOT BALL
- H0868 TITANIUM SCREW SET A
- H0869 TITANIUM SCREW SET B
- C0901 MUFFLER STAY
- H0901 MANIFOLD SPRING
- H0952 WIRE FOR MUFFLER
- H1006 REAR SPOILER ADJ. SCREW
- H1009 BODY STIFFENER

- D0601 BEARING (12x21)
- H0601 BEARING (12x18)
- D0602 BEARING (6x13)
- C0603 CLUTCH BEARING (5x10)
- D0603 5mm THRUST BEARING
- H0603 FLANGE BEARING FOR BELT TENSIONER
- C0605 BEARING FOR SERVO SAVER (6x10)
- H0608 BEARING FOR 2nd. GEAR HOUSING
- H0704 ENGINE NUT
- H0707 CLUTCH SHOE
- H0721 PRESSURE PLATE
- C0723 ENGINE MOUNT FLAT SCREW
- H0751 FLYWHEEL
- H0752 CENTRIFUGAL SHOE
- H0753 SPRING CUP
- H0755 SPRING ADJUST NUT
- H0756 BEARING STOPPER
- H0757 1st. GEAR 16T
- H0758 1st. GEAR 17T
- H0759 1st. GEAR 18T
- H0760 2nd. GEAR 19T
- H0761 2nd. GEAR 20T
- H0762 2nd. GEAR 21T
- H0764 CLUTCH SPRING HARD
- H0765 CLUTCH SHOE (GRAY)
- H0766 LIGHT WEIGHT CENTRIFUGAL SHOE

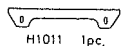
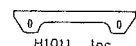

1/8スケールレーシングカーMRX-4X パーツリスト

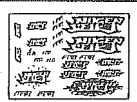

H1010 OPT  H1011 1pc. H1006A 2pcs. H1006B 2pcs.	H1011 OPT  H1011 1pc.	H1101 OPT H1102 OPT  2pcs.
--	---	--

P0218 OPT



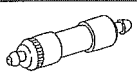
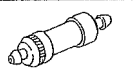

- H1010 REAR SPOILER SET
- H1011 REAR SPOILER
- H1101 FRONT WHEEL (WHITE)
- H1102 REAR WHEEL (WHITE)
- P0218 STICKER FLAG & FLAME

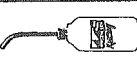
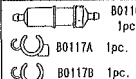
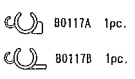

OTHER OPTIONAL PARTS

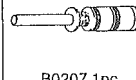

B0010 	B0011 
--	---

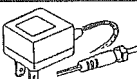

B0103  B0103 1pc.	B0104  B0104 1pc.	B0113  B0113 1pc.
--	---	---

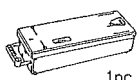

B0115  B0115 1pc.	B0116  B0116 1pc. B0117A 1pc. B0117B 1pc. B0117C 4pcs.	B0117  B0117A 1pc. B0117B 1pc. B0117C 4pcs.
--	---	---



B0203  B0203 1pc.	B0207  B0207 1pc.	B0208  B0208 1pc.
--	---	---

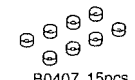

B0209  B0209 1pc.	B0213  B0213 1pc.	B0214  B0214 1pc.
--	---	---

B0220  1pc.	B0233  B0233A 1pc. connector 2pcs.	B0301  B0301 1pc.
--	---	---

B0303  B0303 1pc.	B0316 	B0329  B0329 1pc.
--	---	---

B0330  B0330 1pc.	B0406  B0406 2pcs.	B0407  B0407 15pcs.
--	--	---

B0408  B0408 15pcs.	B0410 B0411 B0412 B0413 B0410 Pink B0411 Green B0412 Yellow B0413 Gray	B0424  4 pcs.
--	---	---

B0506  B0506 1pc.	B0509  B0509 1pc.	B0510  B0510 1pc.
---	---	--

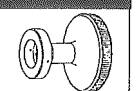
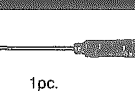
B0514  B0514 1pc.	B0519  1pc.
---	---

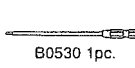
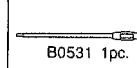

B0529

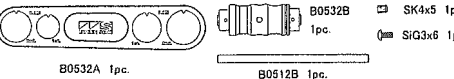
B0529 10pcs.

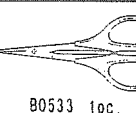
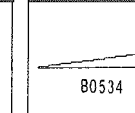
B0519/1  1pc.	B0530  B0530 1pc.	B0531  B0531 1pc.
---	---	--

B0532

B0532A 1pc.
B0512B 1pc.
SK4x5 1pc.
SiG3x6 1pc.

B0533  B0533 1pc.	B0534  B0534 1pc.
---	---

B0663  SG	B0670  SK	B0712  SN
---	---	--

B0722 B0724  OE	B0723  OW	B0730  SiG
---	---	---

B0740  SJG	B0730T  SiG	B0740T  SJG
--	---	--

MSRF30

1Gallon

OTHER OPTIONAL PARTS

- B0010 "AIR BOOSTER" AIR FILTER SET
- B0011 "AIR BOOSTER" AIR FILTER
- B0103 FUEL FILTER L
- B0104 FUEL FILTER S
- B0113 AIR FILTER FOR 210N-ROAD
- B0115 FUEL PUMP 500ml
- B0116 PRESSURE CHAMBER SET
- B0117 PRESSURE CHAMBER MOUNT
- B0203 QUICK BOOSTER
- B0207 POCKET BOOSTER
- B0208 ADAPTER FOR POCKET BOOSTER
- B0209 BATTERY FOR POCKET BOOSTER
- B0213 POWER PACK 1000 (FUTABA)
- B0214 POWER PACK 1000 (SANWA)
- B0220 PRO STARTER RII
- B0233 BATTERY CODE FOR R II/B II
- B0301 LOCK FIRM LIQUID
- B0303 ENGINE MAINTENANCE OIL
- B0316 SUPER SILICON #400
- B0325 SUPER SILICON #500
- B0326 SUPER SILICON #600
- B0327 SUPER SILICON #700
- B0328 SUPER SILICON #800
- B0329 AIR FILTER OIL
- B0330 SUPER JOINT GREASE
- B0332 SUPER SILICON #450
- B0333 SUPER SILICON #550
- B0406 BOTH SIDE TAPE
- B0407 FLAT WASHER 3mm
- B0408 FLAT WASHER 4mm
- B0410 COLOR SILICON PIPE PINK
- B0411 COLOR SILICON PIPE GREEN
- B0412 COLOR SILICON PIPE YELLOW
- B0413 COLOR SILICON PIPE GRAY
- B0424 PORT CAP (L+M)
- B0506 SNAP RING PLIERS
- B0509 SETTING DRIVER FOR ENGINE
- B0510 CAMBER GAUGE
- B0514 CLUTCH SPRING ADJUSTER TOOL
- B0519 (+) #2 SCREW DRIVER
- B0519/1 (+) #2 SCREW DRIVER TIP
- B0520 (+) #1 SCREW DRIVER
- B0520/1 (+) #1 SCREW DRIVER TIP
- B0521 (-) 1.0 SCREW DRIVER
- B0521/1 (-) 1.0 SCREW DRIVER TIP
- B0522 (-) 0.5 SCREW DRIVER
- B0522/1 (-) 0.5 SCREW DRIVER TIP
- B0523 1.5mm Hex. WRENCH
- B0523/1 1.5mm Hex. WRENCH TIP
- B0524 2.0mm Hex. WRENCH
- B0524/1 2.0mm Hex. WRENCH TIP
- B0525 2.5mm Hex. WRENCH
- B0525/1 2.5mm Hex. WRENCH TIP
- B0526 3.0mm Hex. WRENCH
- B0526/1 3.0mm Hex. WRENCH TIP
- B0527 2.0mm Ball-Hex. WRENCH
- B0527/1 2.0mm Ball-Hex. WRENCH TIP
- B0528 2.5mm Ball-Hex. WRENCH
- B0528/1 2.5mm Ball-Hex. WRENCH TIP
- B0529 PROSPEC TOOL SET
- B0530 2.0mm Hex. WRENCH TIP FOR ELECTRIC DRIVER
- B0531 2.5mm Hex. WRENCH TIP FOR ELECTRIC DRIVER
- B0532 PINION GEAR TOOL
- B0533 CURVED SCISSORS
- B0534 HEIGHT GAUGE R
- B0663 SG3x12 CAP SCREW
- B0664 SG3x16 CAP SCREW
- B0670 SK3x3 SET SCREW
- B0671 SK3x5 SET SCREW
- B0672 SK3x12 SET SCREW
- B0675 SK3x16 SET SCREW
- B0681 SK4x5 SET SCREW
- B0682 SK4x8 SET SCREW
- B0690 SK5x5 SET SCREW
- B0712 SN2.6 NYLON NUT (10 pcs.)
- B0713 SN3 NYLON NUT (10 pcs.)
- B0714 SN4 NYLON NUT (10 pcs.)
- B0722 OE-2.5 E-RING
- B0723 OW3x8x0.5 WASHER
- B0724 OE-3 E-RING
- B0730 SiG 3x8 B/H SCREW
- B0731 SiG 3x10 B/H SCREW
- B0732 SiG 3x12 B/H SCREW
- B0733 SiG 3x14 B/H SCREW
- B0734 SiG 3x16 B/H SCREW
- B0735 SiG 3x18 B/H SCREW
- B0736 SiG 3x6 B/H SCREW
- B0740 SJG 3x8 F/H SCREW
- B0741 SJG 3x10 F/H SCREW
- B0742 SJG 3x6 F/H SCREW
- B0743 SJG 3x12 F/H SCREW
- B0746 SJG 4x8 F/H SCREW
- B0747 SJG 4x10 F/H SCREW
- B0750 SJG 4x12 F/H SCREW
- B0730T SiG 3x8T B/H TITANIUM SCREW
- B0731T SiG 3x10T B/H TITANIUM SCREW
- B0732T SiG 3x12T B/H TITANIUM SCREW
- B0733T SiG 3x14T B/H TITANIUM SCREW
- B0734T SiG 3x16T B/H TITANIUM SCREW
- B0735T SiG 3x18T B/H TITANIUM SCREW
- B0736T SiG 3x6T B/H TITANIUM SCREW
- B0740T SJG 3x8T F/H TITANIUM SCREW
- B0741T SJG 3x10T F/H TITANIUM SCREW
- B0742T SJG 3x6T F/H TITANIUM SCREW
- B0743T SJG 3x12T F/H TITANIUM SCREW
- B0746T SJG 4x8T F/H TITANIUM SCREW
- B0747T SJG 4x10T F/H TITANIUM SCREW
- B0750T SJG 4x12T F/H TITANIUM SCREW
- MSRF30 MUGEN SEIKI RACING FUEL30 (NITRO 30% 1GALLON)



株式会社 無限精機 〒274-0817 千葉県船橋市高根町1395
MUGEN SEIKI CO.,LTD.
 1395 Takane-Cho, Funabashi, Chiba 274-0817, Japan
 表示価格には消費税が含まれていません。

H0280

H0281 OPT
H0281 1pc.

H0282
H0282 1pc.

H0283 OPT
H0283 1pc.

H0284 OPT
H0284 1pc.

H0285
H0285 1pc.

H0286 OPT
H0286 1pc.

H0287
H0287 2pcs.

H0288
H0288 1pc.

H0289
H0289 1pc.

H0290
H0290 1pc.
CTW-46 2pcs.

H0291
H0291 2pcs.

H0292
H0292 1pc.

H0293
H0293 1pc.
H0294 1pc.

H0295
SiG3x14 2pcs. $\phi 4$ Ball 2pcs.
SK3x5 2pcs. H0259 2pcs.

H0296 OPT
H0297 2pcs.
H0277 2pcs.
H0273 2pcs.
 $\phi 2.5 \times 11.8$ Pin 2pcs.
SK3x3 2pcs.

H0297 OPT
H0297 2pcs.

H0353
H0353 1pc.

H0354
H0354 2pcs.

H0355 OPT
H0355 2pcs.

H0359
H0359 2pcs.

H0362
H0362A 1pc.
H0362B 2pcs. H0362F 2pcs.
H0362C 2pcs. H0362E 2pcs.
H0362D 2pcs. H0362G 2pcs.

- H0280 PULLEY SET
- H0281 1st. GEAR 48T
- H0282 1st. GEAR 49T
- H0283 1st. GEAR 50T
- H0284 2nd. GEAR 45T
- H0285 2nd. GEAR 46T
- H0286 2nd. GEAR 47T
- H0287 SHOE FOR 2 SPEED GEAR BOX
- H0288 HOUSING FOR 1st. GEAR
- H0289 HOUSING FOR 2nd. GEAR
- H0290 REAR SOLID AXLE
- H0291 REAR DRIVE SHAFT
- H0292 BELT TENSIONER PLATE
- H0293 BELT TENSIONER SHAFT
- H0295 SPRING FOR 2 SPEED GEAR BOX
- H0296 REAR UNIVERSAL JOINT SET
- H0297 REAR DRIVE SHAFT FOR UNIVERSAL
- H0353 BRAKE CAM
- H0354 BRAKE PLATE
- H0355 BRAKE PAD
- H0359 TEFLON BRAKE PAD
- H0362 SERVO MOUNT PARTS

H0365
H0356 1pc.

H0366
H0366 1pc.

H0367
H0367 1pc.

H0368
H0368 10pcs.

H0369
H0369 1pc.

H0370
H0370 1pc.

H0371
H0371A 1pc. H0371B 1pc. H0371C 1pc. H0371D 1pc. H0371E 1pc.
H0371F 1pc. H0371G 1pc. H0371H 1pc. H0371I 1pc. H0371J 1pc.

H0372
H0372A 1pc. H0372B 1pc.
H0372C 1pc. H0372D 1pc.

H0373
H0363A 1pc. H0363B 1pc. H0363C 2pcs. H0363F 1pc. H0363G 1pc.

H0374
H0374 1pc.

H0375 OPT
H0375 1pc.

H0463
H0463 1pc.

H0465
H0465A 1pc. H0465B 2pcs. H0465D 2pcs. H0465C 2pcs. H0465E 2pcs.

H0466-B
H0466C 2pcs. H0466F 2pcs. H0466B 2pcs. H0466E 1pc.

H0467
H0467 1pc.

H0468
H0468 1pc.

H0469
H0469 2pcs.

H0470
H0470 2pcs.

H0471
H0471 4pcs.

H0473 OPT
H0473 1pc.

H0475
H0475 1pc. 3x17 Spring Pin 2pcs.

D0506
D0506 2pcs.
 $\phi 2.6 \times 6 \times 0.5$ 2pcs.
SN2.6 2pcs.

- H0365 SERVO SAVER SHAFT
- H0366 SERVO SAVER PIPE
- H0367 SERVO SAVER SPRING
- H0368 GROMMET
- H0369 VENTILATED BRAKE DISK
- H0370 RADIO PLATE
- H0371 TH SERVO MOUNT
- H0372 SERVO SAVER ARM
- H0373 RADIO MOUNT PARTS
- H0374 BATTERY HOLDER FRP
- H0375 BATTERY HOLDER CFRP
- H0463 FRONT BUMPER
- H0465 FRONT BODY MOUNT
- H0466-B REAR BODY MOUNT
- H0467 REAR BODY MOUNT CENTERING PLATE
- H0468 REAR BODY MOUNT CENTERING SHAFT
- H0469 REAR BODY MOUNT ARM SHAFT
- H0470 REAR BODY MOUNT ARM STOPPER
- H0471 REAR BODY MOUNT ARM PIN
- H0473 FRONT BODY MOUNT PLATE CFRP
- H0475 CHASSIS
- D0506 REAR DAMPER SHAFT

D0508
D0508 8pcs.

D0509
O 9509A 8pcs. C 0509C 4pcs.
P3 O-Ring 8pcs. O-Ring

H0510
H0510F 2pcs.
H0510R 2pcs.

H0511 OPT
H0511 $\phi 1.9$ mm 2pcs. BLACK

H0513
H0513 2pcs. 3/2 O-Ring 2pcs. O-Ring

H0515 OPT
H0515 $\phi 1.8$ mm 2pcs. YELLOW

H0516 OPT
H0516 $\phi 2.0$ mm 2pcs. BLUE

H0525 OPT
H0525 $\phi 1.8$ mm 2pcs. GRAY

H0526
H0526 $\phi 1.9$ mm 2pcs. WHITE

H0529 OPT
H0529 $\phi 1.8$ mm 2pcs. GRAY

H0530
H0530 $\phi 1.9$ mm 2pcs. WHITE

H0531 OPT
H0531 $\phi 2.0$ mm 2pcs. PINK

H0532 OPT
H0532 $\phi 2.0$ mm 2pcs. RED

H0554
H0554 2pcs.

H0558 OPT
H0558 2pcs. (Black)

H0559 OPT
H0559 2pcs. (White)

H0560
H0560 1pc.

H0561
H0561 1pc.

H0562
H0562 2pcs.

H0563
H0563 2pcs.

H0566 OPT
H0566 1pc.

H0570
H0562 2pcs. H0563 2pcs. H0554 2pcs. D0506 2pcs. D0508 2pcs. D0510F 2pcs. D0510R 2pcs. H0555A 4pcs. H0555B 4pcs. H0555C 2pcs. H0555D 2pcs. H0555E 2pcs. H0867 4pcs. D0509A 4pcs. P3 O-Ring(Si 白) 4pcs. OW2.6x6x0.5 2pcs. H0858 2pcs. SN2.6 2pcs. (Nylon Lock Nut) S12 O-Ring 2pcs.

H0571
H0555A 4pcs. H0555B 4pcs. H0555C 2pcs. H0555D 2pcs. H0555E 2pcs.

- D0508 DIAPHRAGM
- D0509 O-RING SET
- H0510 DAMPER PISTON
- H0511 FRONT DAMPER SPRING BLACK $\phi 1.9$ mm
- H0513 SPRING ADJUSTER
- H0515 FRONT DAMPER SPRING YELLOW $\phi 1.8$ mm
- H0516 FRONT DAMPER SPRING BLUE $\phi 2.0$ mm
- H0525 FRONT DAMPER SPRING GRAY $\phi 1.8$ mm
- H0526 FRONT DAMPER SPRING WHITE $\phi 1.9$ mm
- H0529 REAR DAMPER SPRING GRAY $\phi 1.8$ mm
- H0530 REAR DAMPER SPRING WHITE $\phi 1.9$ mm
- H0531 REAR DAMPER SPRING PINK $\phi 2.0$ mm
- H0532 REAR DAMPER SPRING RED $\phi 2.0$ mm
- H0554 DAMPER CAP
- H0558 DAMPER PISTON ($\phi 1.2$)
- H0559 DAMPER PISTON ($\phi 1.3$)
- H0560 FRONT DAMPER STAY
- H0561 REAR DAMPER STAY
- H0562 DAMPER CASE
- H0563 OIL SEAL CAP
- H0566 FRONT DAMPER STAY
- H0570 DAMPER SET
- H0571 DAMPER PARTS

1/8th Scale 4WD Gas Powered Racing Car MRX-4X Parts List

H0086 	H0087 	H0088
D0104R 	H0104L 	
J0105U 	D0105R 	H0107/1
H0135 	H0136-B 	
H0137 	H0138 	
H0139-B 	H0140-B 	
H0141 	H0142 	
H0143 	H0144 	H0145
H0146 	H0147 OPT 	
H0148-B 	H0149-B 	T0154

- H0086 INSTRUCTION MANUAL
- H0087 DECAL MRX-4X
- H0088 DECAL MRX-4X 3pcs.
- D0104R REAR LOWER SUS. SHAFT
- H0104L FRONT LOWER SUS. SHAFT
- J0105U REAR UPPER SUS. SHAFT
- D0105R KING PIN
- H0107/1 FRONT STABILIZER BAR
- H0135 FRONT UPPER ARM
- H0136-B REAR UPPER ARM
- H0137 FRONT LOWER ARM
- H0138 REAR LOWER ARM
- H0139-B FRONT UPRIGHT
- H0140-B REAR UPRIGHT
- H0141 FRONT ANTI-ROLL BAR HOLDER
- H0142 RADIO PLATE MOUNT
- H0143 MIDDLE SHAFT BRACKET
- H0144 KING PIN BALL CUP
- H0145 ADJUST NUT
- H0146 SUS. ARM SPACER
- H0147 REAR UPPER ARM SET
- H0148-B FRONT BULKHEAD
- H0149-B REAR BULKHEAD
- T0154 ECCENTRIC HUB

H0158 	OPT	H0161
H0163 	H0164 	H0180
H0181 OPT 	H0181A OPT 	H0181B OPT
H0181C OPT 	H0181D 	H0185 OPT
H0186 OPT 	H0187 OPT 	H0187/1 OPT
H0188 	H0189 	
H0190 	H0191 	
H0205 	D0206 	H0208 OPT
J0209 	H0222 	

- H0158 FRONT UPRIGHT
- H0161 FRONT UPPER SUS. SHAFT
- H0163 REAR ANTI-ROLL BAR
- H0164 ROLL BAR
- H0180 REAR UPRIGHT BALL
- H0181 REAR UPRIGHT SPACER
- H0181A 3mm SPACER 0.5mm
- H0181B 3mm SPACER 1.0mm
- H0181C 3mm SPACER 2.0mm
- H0181D 3mm SPACER 3.0mm
- H0185 REAR ADJUSTABLE ANTI-ROLL BAR SET
- H0186 REAR ADJUSTABLE ANTI-ROLL BAR
- H0187 TITANIUM KING PIN BALL (2 pcs.)
- H0187/1 TITANIUM KING PIN BALL (8 pcs.)
- H0188 ECCENTRIC HUB
- H0189 UPRIGHT SPACER
- H0190 BRAKE BRACKET
- H0191 REAR LOWER ARM MOUNT
- H0205 PULLEY HUB
- D0206 INNER DRIVE JOINT
- H0208 FRONT AXLE SHAFT
- J0209 MIDDLE SHAFT
- H0222 REAR AXLE SHAFT

D0240 	H0240 	
H0241 		
H0245 OPT 	H0246 OPT 	
H0247 OPT 		
H0252 	H0253 OPT 	H0255
H0256 		
H0257 	H0268 	H0269 OPT
H0270 	H0271 	
H0272 		
H0273 	H0274 	
H0275 	H0277 OPT 	H0279

- D0240 BELT S 6mm
- H0240 BELT S 8mm
- H0241 BELT L 6mm
- H0245 BELT S 6mm RUBBER
- H0246 BELT S 9mm RUBBER
- H0247 BELT L 6mm RUBBER
- H0252 FRONT ONE WAY DRIVE AXLE
- H0253 FRONT DRIVE SHAFT
- H0255 BRAKE PULLEY ADAPTER
- H0256 2 SPEED SHAFT
- H0257 2 SPEED ADAPTER
- H0268 AXLE WASHER
- H0269 TITANIUM MIDDLE SHAFT
- H0270 FRONT UNIVERSAL JOINT SET
- H0271 FRONT AXLE SHAFT FOR UNIVERSAL
- H0272 FRONT DRIVE SHAFT FOR UNIVERSAL
- H0273 JOINT SHAFT FOR UNIVERSAL
- H0274 ROLLER PIN 2.5x11.8 (10 pcs.)
- H0275 FRONT WHEEL CHANGE LEVER
- H0277 REAR AXLE SHAFT FOR UNIVERSAL
- H0279 REAR WHEEL CHANGE LEVER